

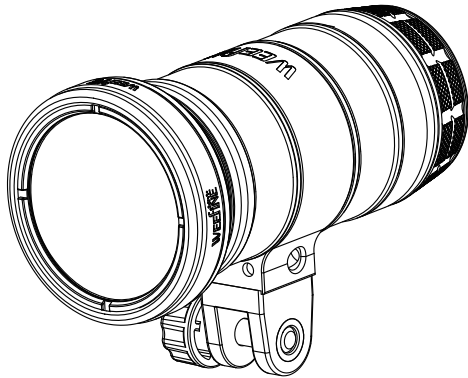

Smart Focus 10000

USER MANUAL



10000 Lumens
Waterproof to 100m/330ft

Please read the manually carefully before using the focus light

Features

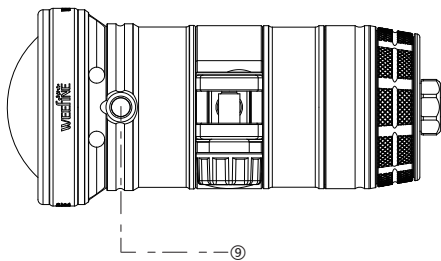
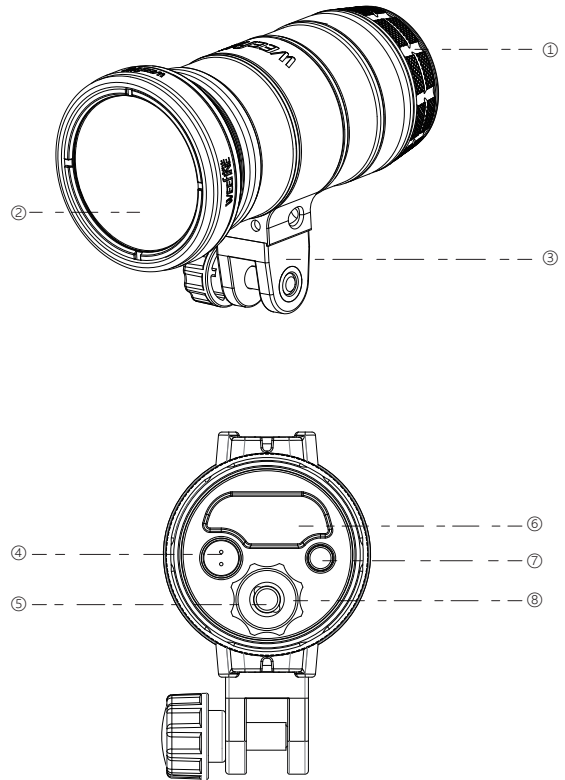

- ① Tail cap
- ② Wide Light
- ③ YS Adapter
- ④ Release valve
- ⑤ Push button
- ⑥ Screen display
- ⑦ Remote control port
- ⑧ Adjustment knob
- ⑨ Strobe Port

Standard Accessories

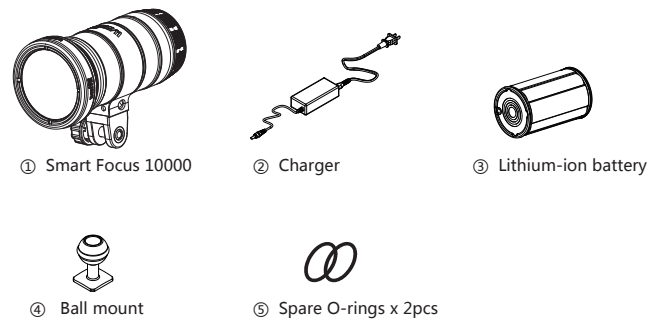

Specification

Brightness	10000 Lumens/5700K/CRI:80
Strobe mode	Max.12000 Lumens/5700K/CRI:80
Beam Angle	120 Degrees
Battery	4 x 21700 Lithium-ion batteries
Burn Time	Approx. 60 min (100% flood)
Depth Rated	100m / 330ft
LED Life	Over 50,000 hours
Dimensions	163mmx73mmx107 mm
Weight	825g on land (Including the battery) 380g in water (Including the battery)

To install the battery

1. Turn the tail cap counter-clockwise.
2. Put the Lithium-ion battery into the battery compartment, the Battery compartment is located in the body (as the diagram showed below).
3. Tighten the tail cover clockwise.
(i.e. reattach the tail to the light head).

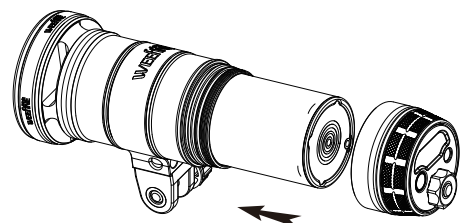

To operate the light

Turn ON: (When the light is OFF) Press the Button and hold it down for 1 second, the display is bright fully and then enters the flashing mode with 100% brightness;

Turn OFF: (When the light is ON) Press the Button and hold it down for 2 seconds;

Mode switch

When the light is ON: Press and immediately release the Button.

White light → Red light → Blue light → Green light → Red light + Blue

light + Green light (Manual color adjustment mode) → Red light + Blue

light + Green light (Automatic color adjustment mode) → white light;

Brightness adjustment

Rotate clockwise +, rotate counterclockwise-;

White light, Red light, Blue light, Green light: Totally 11 levels from 0 to 100,

the second level is 10%;

Red light + Blue light + Green light (color adjustment mode) :

Totally 60 levels from 1 to 60;

SOS flash and strobe:

(When the light is OFF) Press the Button and hold it down for more than 3 seconds,

The SOS mode will be on, press and immediately release the button: SOS → Rapid

Strobe → SOS Press the Button and hold it down for more than 2 seconds,

the light will be off;

Temperature protection function

When the lamp holder temperature reaches 60°C it enters the temperature protection

function with 20% lightness and the display shows "HOT"; when the temperature is

below 40°C, it exits the temperature protection function and the lightness turns

to normal status;

Strobe function

This function is intended to help photographers use low-brightness white light or colored light to provide a focus light source. When the camera shutter is pressed, the white light will strobe for 0.1 second. At the same time, the focus light goes out, which realizing the effect of taking photos. The focus light will be turned on again after the strobe light goes out.

- When using this function, you need to use the optical fiber cable to connect the camera and the torch.

To Charge the battery

1. Connect the AC charge plug to the power socket, and the indicator of the charger will turn green.

2. Insert the DC charger plug into the battery charging hole, and the indicator of the charger will turn from green to red .

3. When the battery is fully charged, the indicator light on the charger will turn green.

4. Don't use the other brand charger to charge in case of fire and explosion .

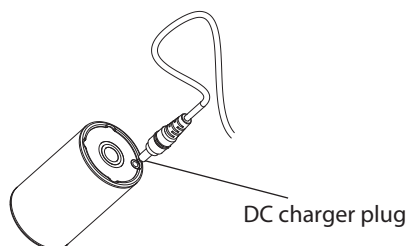

Low power protection

When the power is low, the brightness is reduced to 10% with display of 10 minutes countdown. It turns off automatically after 10 minutes. The flashing function is available under this status.

Remote control function

Support WFA03 remote control. Connect the torch and WFA03 with optical fiber cable;

Operation: Press the left button to reduce brightness.

Press the right button to increase brightness.

Press the middle button to switch the mode.

Long press the middle button to enter the sleeping mode and Long press the middle button again to wake it up.

Remote control :

WFA03 remote control and optical fiber cable are optional accessories.

Operation method

1. Select the focus light source : Under the normal working condition, select the required light source and adjust the appropriate brightness to focus.
2. Strobe mode : When the light is on, press and hold the button for 1.5 seconds to enter the strobe mode, then the strobe sign and white light indicator light on the screen is flashing, and the default brightness value is the highest that show number 9 on the screen .
3. Select the strobe levels : rotate the knob to adjust the white strobe brightness, turn counter-clockwise to decrease the levels; turn clockwise to increase the levels. (There are 9 levels)

Focus function

Under the strobe mode, adjust the strobe brightness to 0% through rotating the knob counter-clockwise .

When the light sensor detects the strobe light, the torch will automatically turn off and light up again one second later.

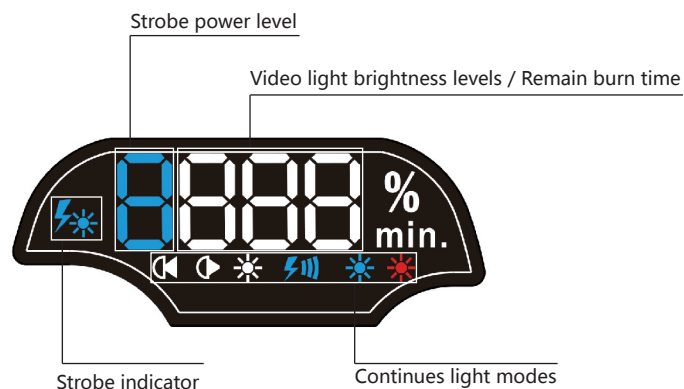

General maintenance

1. Put the torch into freshwater soaking for half an hour after diving.
2. When the battery is not in use for a long time, it is best to save the power at 70%.
3. The battery need to be charged and released at most every 6 months.
4. Before using the torch , check the O-ring of the tail cap to see whether there is any damage , cracks ,clamping marks, dirt , sand and so on.
5. Keep the silicon oil on the whole O-ring at the light tail .
6. The O-Ring should be replaced on time when it is cracked or damaged.

Note: Don't use the sharp tools to remove the O-Ring .

Warnings

- ★ Do not open the tail cap when the torch is in the water;
- ★ Do not shine the light directly into your eyes or another person's eyes;
- ★ Do not touch the battery or the charger with wet hands;
- ★ Only use the manufacturer's battery and charger with this system;
- ★ If the torch will not be used for a long period of time the battery should be removed. Failure to comply with these warnings may result in damage to the video light and will nullify the warranty.
- ★ Don't disassemble or repair the torch , battery and charger by yourself. Please contact the local distributor in case of failure.